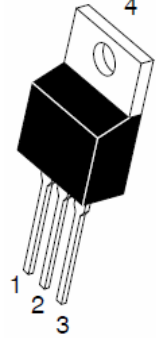
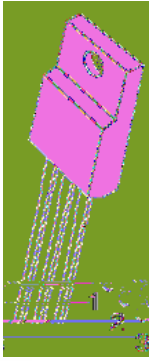
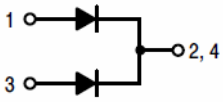

7UHQFK 026 %DUULHU 6FKRWWN\ 5H

<p>TO-220AB TSR &amp; 7</p>	<p>ITO-220AB TSR &amp; 7)</p>	<p><b>Features</b></p> <ul style="list-style-type: none"> <li>‡ \$GYDQWUHQFK WHFKQRORJ\</li> <li>‡ /RZRZURGRWDJH GURS</li> <li>‡ /RZRZURVHV</li> <li>‡ +LJKILFLHQF\ RSHUDWLRO</li> <li>‡ /HDGH)HLQLVK &amp;RPSOLDQW</li> </ul>				
		<p><b>Applications</b></p> <ul style="list-style-type: none"> <li>‡ '&amp;' &amp; RQYHUWHUV</li> <li>‡ \$&amp;' &amp; GDSWRUV</li> <li>‡ 6ZLWFKRZHXSSOLHV</li> <li>‡ )UHHZKH)HLGRQJ</li> </ul>				
						
<p>Maximum ratings and electrical characteristics (T<sub>J</sub> = 25°C unless otherwise noted)</p>						
<p>3DUDPHWHU</p>		<p>6\PERO</p>	<p>/LPLW</p>	<p>8QLW</p>		
<p>0D[LPXPHSHVSHUNYHYURQHW DJH</p>		<p>9550</p>		<p>9</p>		
<p>0D[LPXPHUDRJRZDUG UFXEWHIHWG</p>	<p>GHYLFH SHGLRGH</p>	<p>,) \$9</p>		<p>\$</p>		
<p>3HDN IRVZDUEBUHQW VLQDQH ZDYH VXSHULPSRVHGRFSGUDRCHG</p>		<p>,)60</p>		<p>\$</p>		
<p>2SHUDMXQDQGRQWRUDJH WHPSHUDW</p>		<p>XOH 060JH</p>	<p>WR</p>	<p>f&amp;</p>		
<p>7\SLFVCHUPDO USHVULVQHDQFH</p>	<p>72 \$% ,72 \$%</p>	<p>5\$-&amp;</p>		<p>f&amp; : f&amp; :</p>		
<p>,QVWDQWDQHRRQWRUDRZDUG SHGLRGH</p>		<p>9)</p>	<p>7&lt;3</p>	<p>0\$;</p>	<p>9</p>	
	<p>,) \$</p>		<p>7- f&amp;</p>			
	<p>,) \$</p>		<p>7- f&amp;</p>			
	<p>,) \$</p>		<p>7- f&amp;</p>			
<p>,QVWDQWDQHRXUUSHQWRUDRZDUG UDWHYHYURQHW DJH</p>	<p>7- f&amp; 7- f&amp;</p>	<p>,5</p>			<p>X\$ P\$</p>	
			<p>1RWHV 3XOVH WHVVSXOVH ZLGWK GXW\FFOH 3XOVH WHVW 3XOPVH ZLGWK 0</p>			

---

PACKAGE OUTLINE DIMENSIONS

1RWH XQLW ,Q PP

TO-220AB

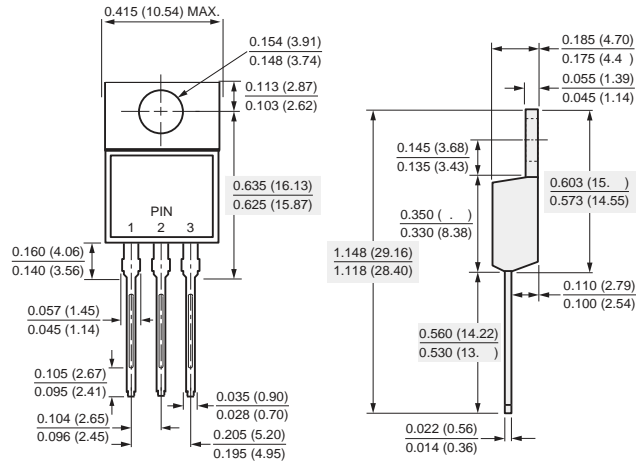

ITO-220AB

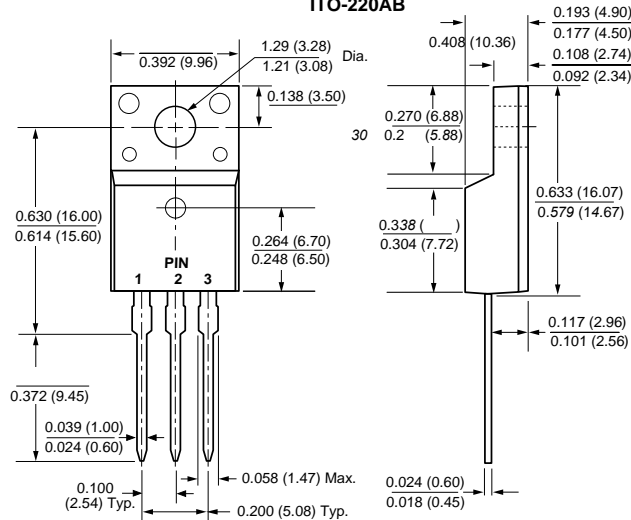

### Marking Information

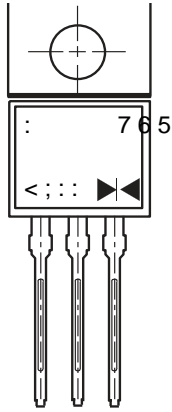

3URGXFW 765 910 & 7RU 765 (7)  
 3' & LQIRUPDWLRQ

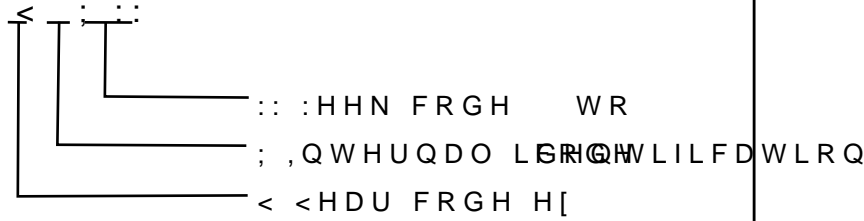

### Packaging Information

7XEH 'LPHQVLRQV

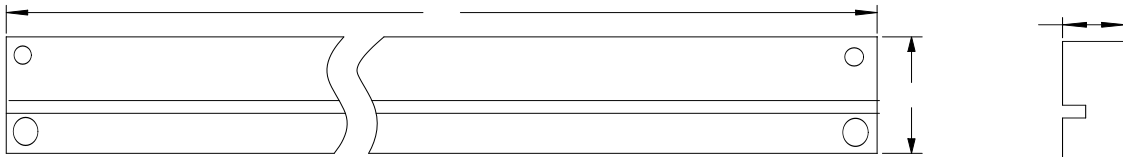

,QVLGH %R[

2XWVLGH %R[

### Packaging Information

12	81,	7XEH 'LPHQVLRQV			,QVLGH %R[			2XWVLGH %R[		
6L]H	PP	\$	%	&	/	:	+	/	:	+
47<	3&6	3&6 7XEH			6PDO SHFWDJH3&6 WXE VRWDO			3&6 FDUERGLWRWDO		
1RWH		7ROHUDQFH PP" PP			PP" PP			PP" PP		