

TSP5L80SP

Features

TSP5L80SP

TO-277



Applications

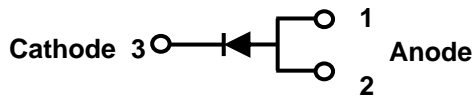

Maximum ratings and electrical characteristics (T_J = 25°C unless otherwise noted)



TSP5L80SP

RATINGS AND CHARACTERISTICS CURVES

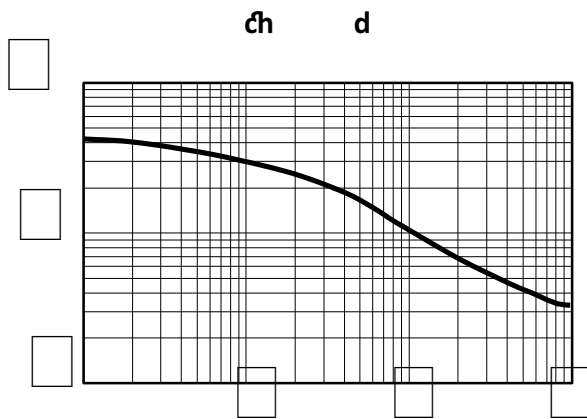
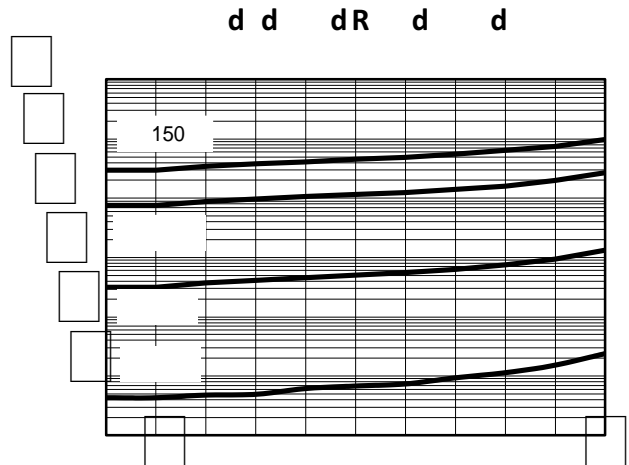
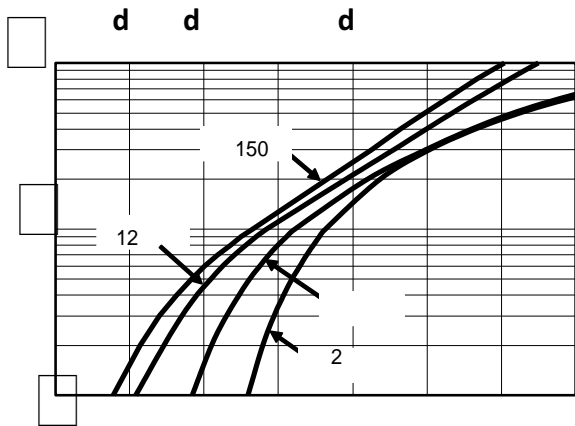
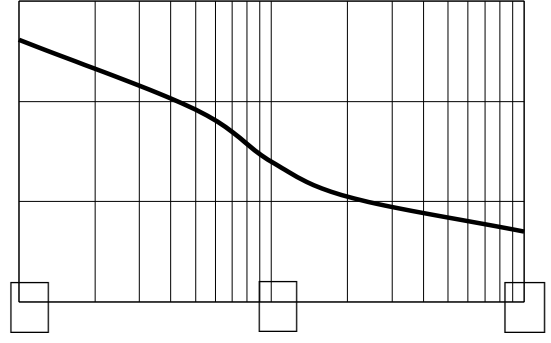
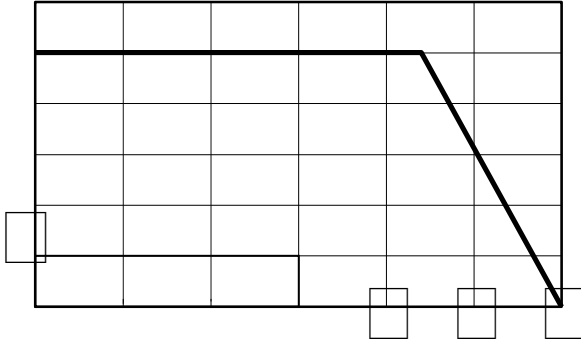

d d d d

d

TSP5L80SP

PACKAGE OUTLINE DIMENSIONS

TO-277

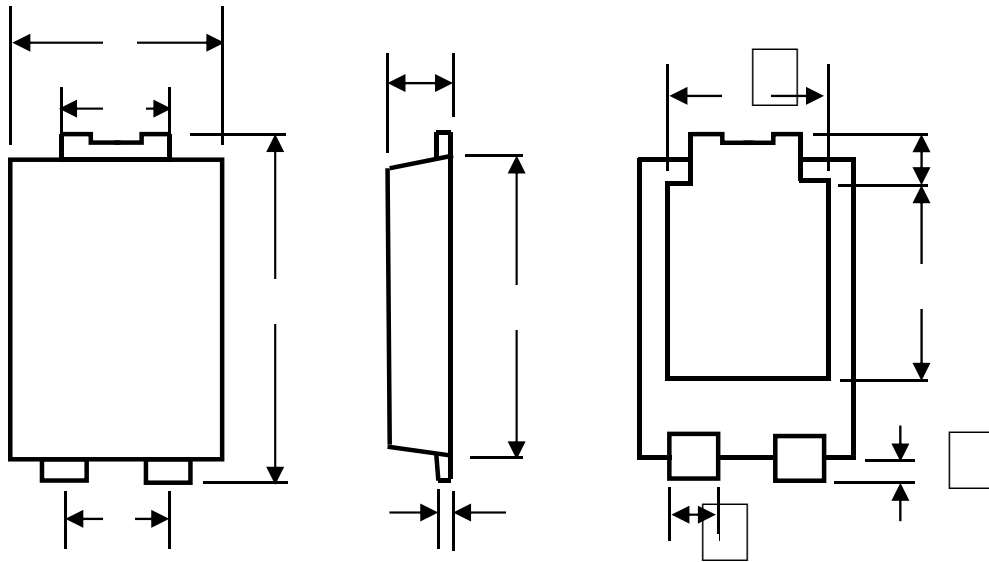

TO-277 mechanical data

TO-277 Suggested Pad Layout

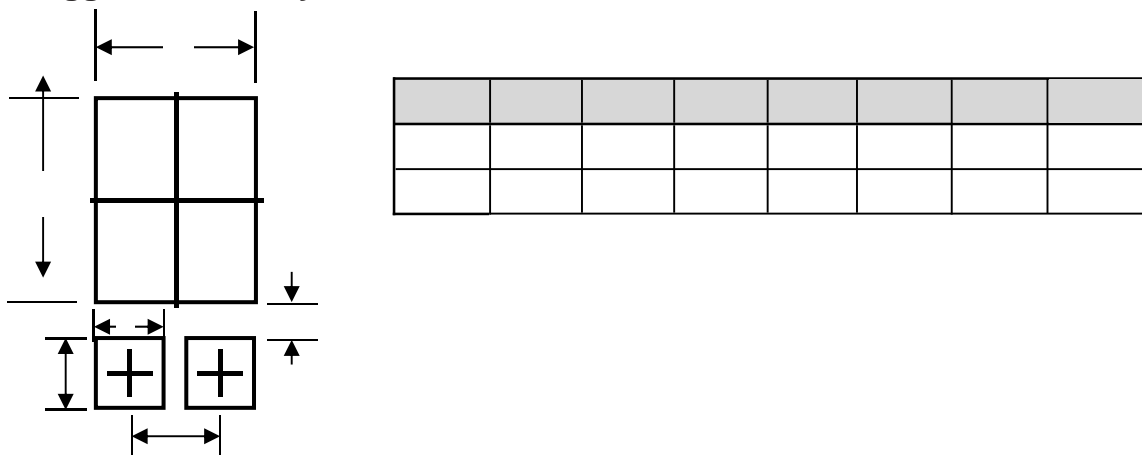

TSP5L80SP

Marking Information

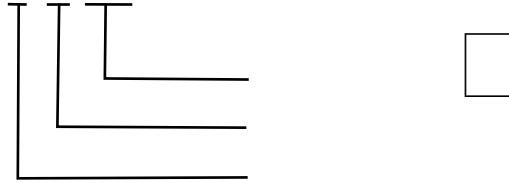
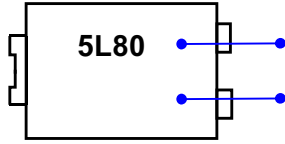

Packaging Information

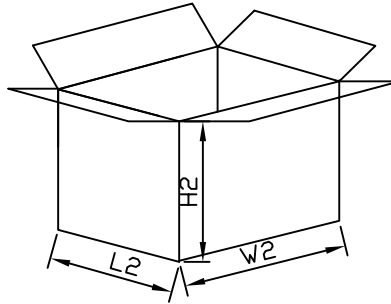
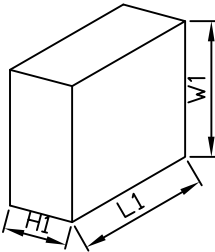
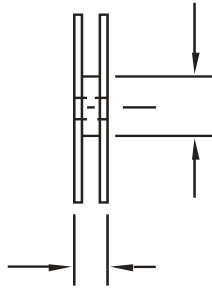
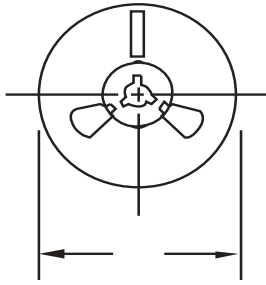

Packaging Information

