

7UHQFK 026 %DUULHU 6FKRWWN\ 5H

72 \$%  
765 / &7

,72 \$%  
765 / &7)

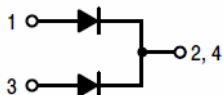
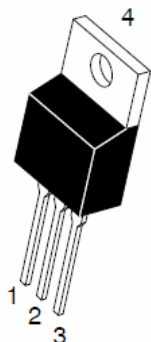

)HDXUHV

‡ \$GYDQWUHQFK WHFKQRORJ\ \\  
‡ /RZRUZDURGDWDJH GURS  
‡ /RZRZURVVHV  
‡ +LJKILFLHQF\ RSHUDWLRQ  
‡ /HDGH)HLQLVK &RPSOLDQW

\$SSOLFDFWLRQV

‡ '& '& &RQYHUWHUV  
‡ \$& '\$GDSWRUV  
‡ 6ZLWFKRZHXSSOLHV  
‡ )UHHZKHHLRGLJ

0D[LPXP UDWLQJV DQG HOHFWULFDJ& FXODDPRVHUQRVWHIGFV

3DUDPHWHU		6\PERO	/LPLW	8QLW
0D[LPXP SHSHVSHUNYHYURQHW DJH		9550		9
0D[LPXPYHURJHZDUG UFXEWHIHWG	GHYLFH SHGLRGH	,) \$9		\$
3HDN IRVZDURSUHQW VLKDDHQH ZDYH VXSHULPSRVHGRFSGUDRCHG		,)60		\$
2SHUDMXQRDQQRWRUDJH WHPSHUDW		XUH 0DQJH	WR	
7\SLFVCHUPDO USHVULVQHWQFH		72 \$% ,72 \$%	5\$-&	f & : f & :
,QVWDQWDQHRRQWRUJZDUG SHGLRGH			7<3	0\$;
	,) \$	7- f&		
	,) \$	7- f&		
	,) \$	7- f&		
,QVWDQWDQHRXUUSHQWRDWH UDWHYHYURQHW DJH		7- f&		X\$
		7- f&	,5	P\$

1RWHV

3XOVH WHVWSXOVH ZLGWK GXW\ F\FOH

3XOVH WHVW 3XOVH ZLGWK 0 PV

5 \$ 7 , 1 \* 6 \$ 1 ' & + \$ 5 \$ & 7 ( 5 , 6 7 , & 6 & 7 8 5 9 ( 6 f & X Q O H V Q R W K B U Z L V H

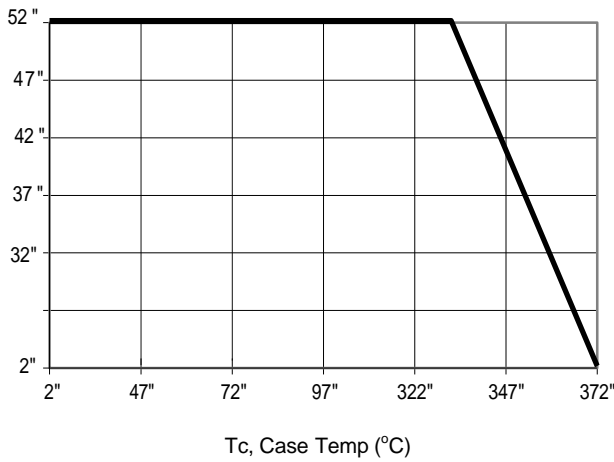

$\mu$   $\infty$   $\infty$   $\infty$  v šš • ] v P U

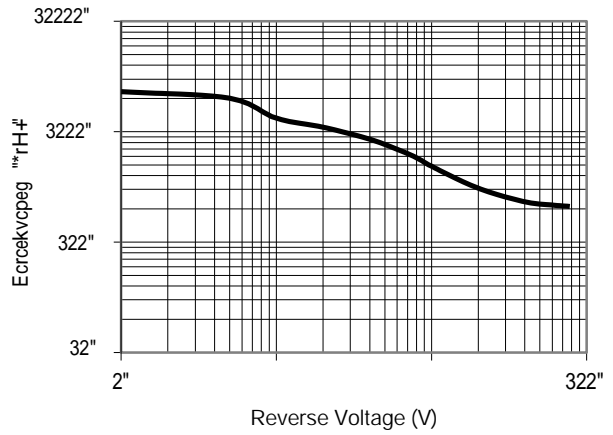

Typical Junction Capacitance

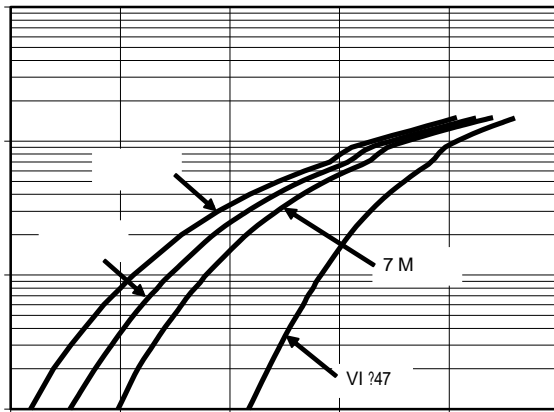

91 , Q V D V D B R X ) R U D U G 9 R O W D J I R 9

Typical Forward Voltage

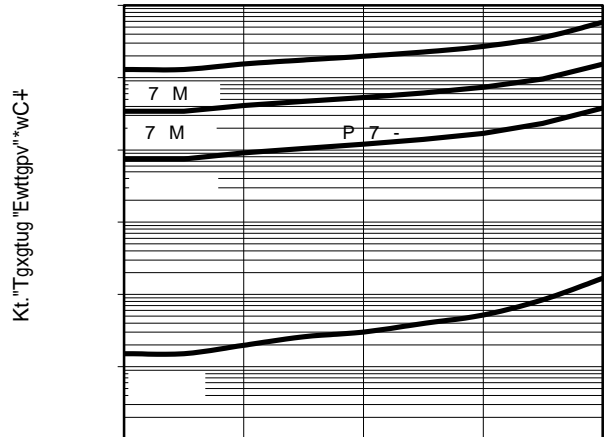

VR, Reverse Voltage (Volts)

d Ç % ] Å  $\mu$   $\infty$  •  $\infty$  v š

3 \$ & . \$ \* ( 2 8 7 / , 1 ( ' , 0 ( 1 6 , 2 1 6

TO-220AB

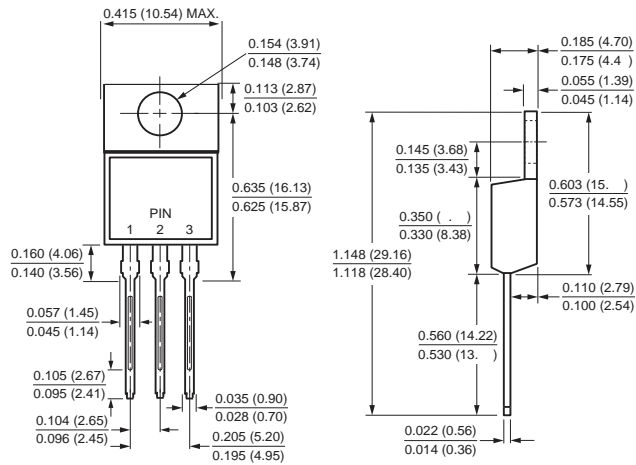

ITO-220AB

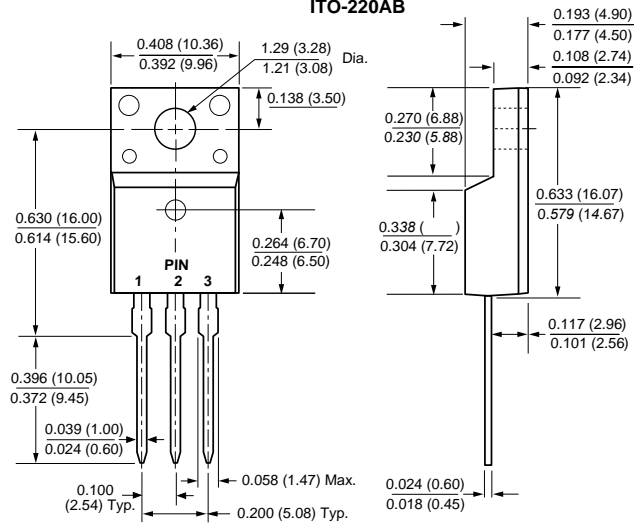

0DUNLQJ ,QIRUPDWLRQ

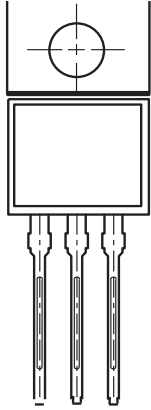

3URGXFW 765 / &7) 3' & LQIRUPDWLRQ

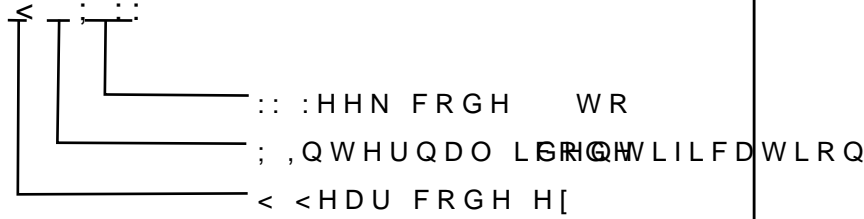

3DFNDJLQJ ,QIRUPDWLRQ

7XEH 'LPHQVLRQV

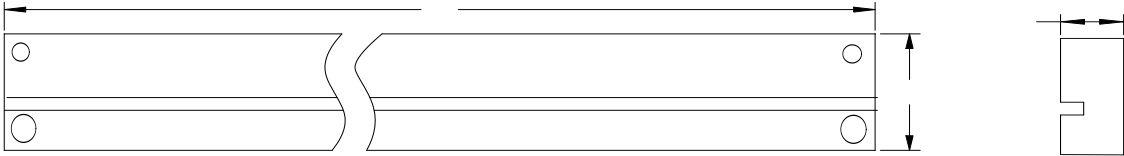

,QVLGH %R[

2XWVLGH %R[

3DFNDJLQJ ,QIRUPDWLRQ

12	81,	7XEH 'LPHQVLR			,QVLGH			2XWVLGH %R[		
6L]H	PP	\$	%	&	/	:	+	/	:	+
47<	3&6	3&6 7XEH			6PDOO 3DFWDJH3&6 WXEORWDO			3&6 FDUERGLWDO		
1RWH		7ROHUDQFH PP" PP			PP" PP			PP" PP		