

TO-220AB
TSR 6 CT

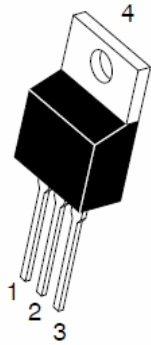

ITO-220AB
TSR 6 CTF

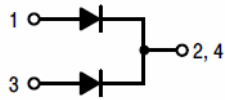
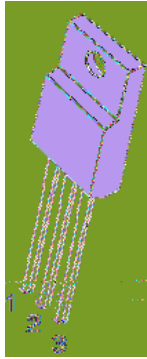

Features

- ‡ \$GYDQWUHQFK WHFKQRORJ\
- ‡ /RZRUZDYGWDJH GURS
- ‡ /RZRZURVVHV
- ‡ +LJKILFLHQF\ RSHUDWLRO
- ‡ /HDGH)HLQLVK &R#6OLDQW

RATINGS AND CHARACTERISTICS CURVES

7\$

f & X Q O H V Q R W K B U Z L V H

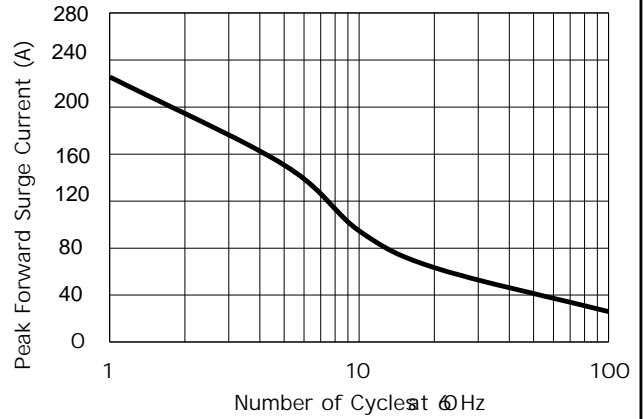
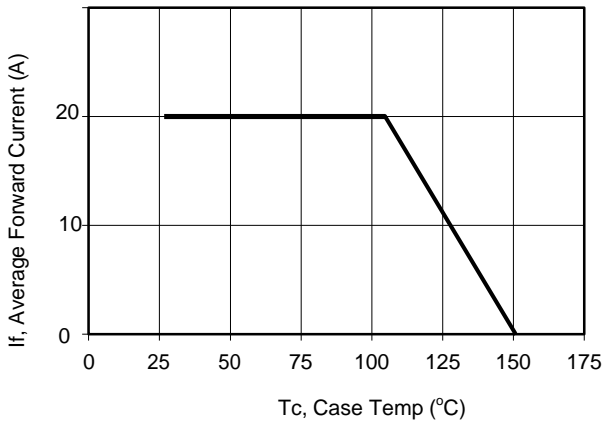

Current Derating, Case

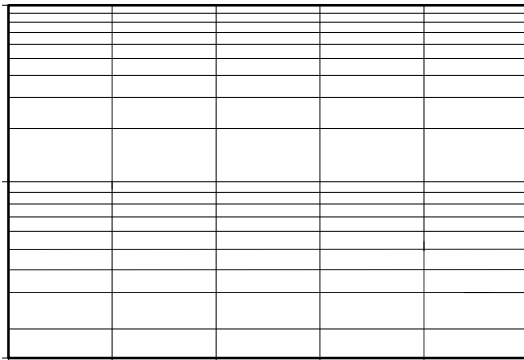

Maximum Repetitive Surge Current

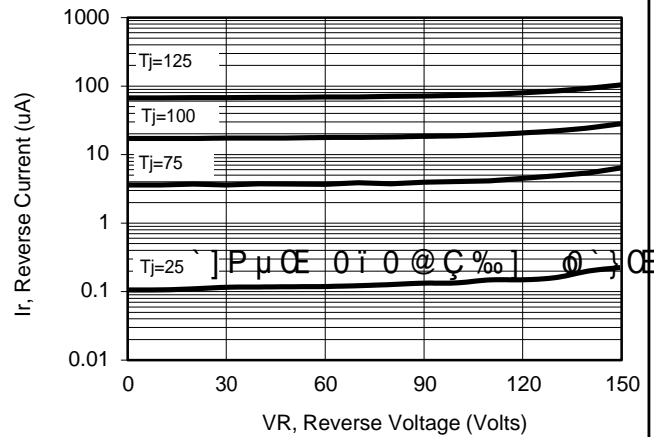

Typical Reverse Current

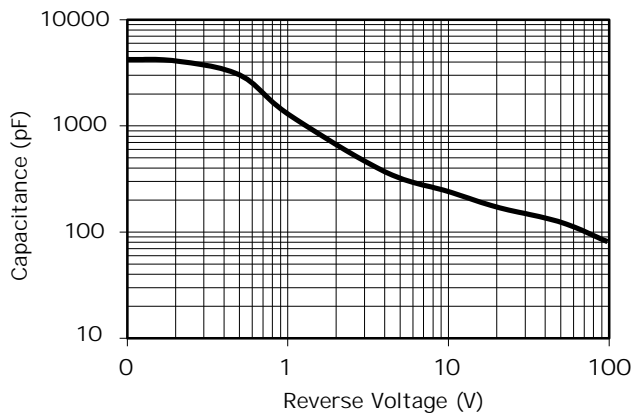

Typical Junction Capacitance

PACKAGE OUTLINE DIMENSIONS 888

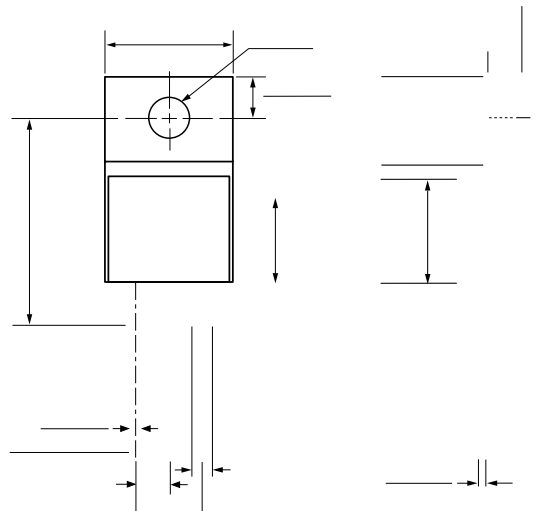

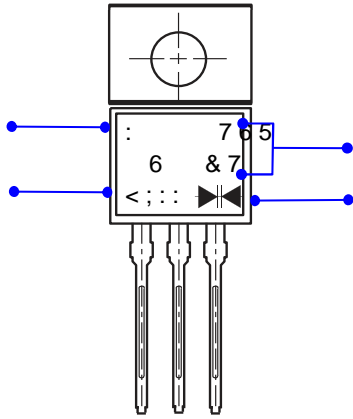

3URGXFW 765GH60 &7 RU 765 &7)
3' & LQIRUPDWLRQ

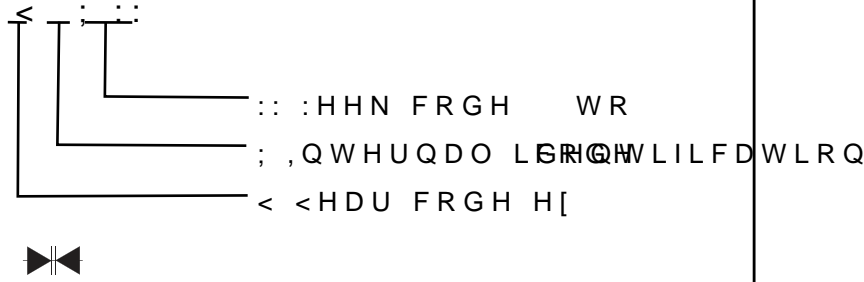

7XEH 'LPHQVLRQV

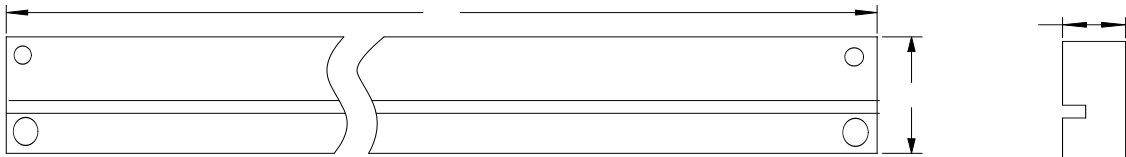

,QVLGH %R[

2XWVLGH %R[

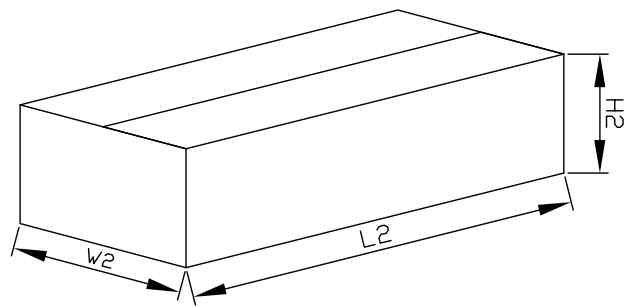
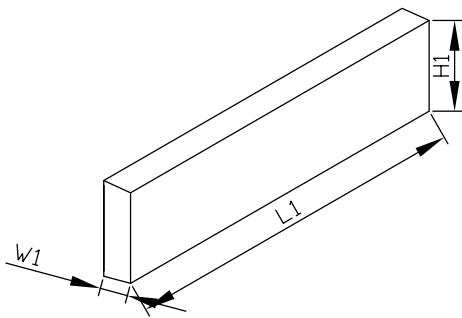

| 12 | 81, | 7XEH 'LPHQVLRQV | | | ,QVLGH %R[| | | 2XWVLGH %R[| | |
|------|-----|------------------|---|---|-----------------------------|---|---|-----------------|---|---|
| 6L]H | PP | \$ | % | & | / | : | + | / | : | + |
| 47< | 3&6 | 3&6 7XEH | | | 6PDO SHVWDJH3&6 WXEWRWDO | | | 3&6 FDUERQWRWDO | | |
| 1RWH | | 7ROHUDQFH PP" PP | | | PP" PP | | | PP" PP | | |